

FEATURES

High performance, single/dual axis accelerometer on a single IC chip

5 mm \times 5 mm \times 2 mm LCC package

1 mg resolution at 60 Hz

Low power: 700 μ A at $V_S = 5$ V (typical)

High zero g bias stability

High sensitivity accuracy

-40°C to $+125^\circ\text{C}$ temperature range

X and Y axes aligned to within 0.1° (typical)

BW adjustment with a single capacitor

Single-supply operation

3500 g shock survival

APPLICATIONS

Vehicle Dynamic Control (VDC)/Electronic Stability Program (ESP) systems

Electronic chassis control

Electronic braking

Platform stabilization/leveling

Navigation

Alarms and motion detectors.

High accuracy, 2-axis tilt sensing

GENERAL DESCRIPTION

The ADXL103/ADXL203 are high precision, low power, complete single and dual axis accelerometers with signal conditioned voltage outputs, all on a single monolithic IC. The ADXL103/ADXL203 measures acceleration with a full-scale range of $\pm 1.7 g$. The ADXL103/ADXL203 can measure both dynamic acceleration (e.g., vibration) and static acceleration (e.g., gravity).

The typical noise floor is $110 \mu\text{g}/\sqrt{\text{Hz}}$, allowing signals below 1 mg (0.06° of inclination) to be resolved in tilt sensing applications using narrow bandwidths (< 60 Hz).

The user selects the bandwidth of the accelerometer using capacitors C_X and C_Y at the X_{OUT} and Y_{OUT} pins. Bandwidths of 0.5 Hz to 2.5 kHz may be selected to suit the application.

The ADXL103 and ADXL203 are available in 5 mm \times 5 mm \times 2 mm, 8-pad hermetic LCC packages.

FUNCTIONAL BLOCK DIAGRAM

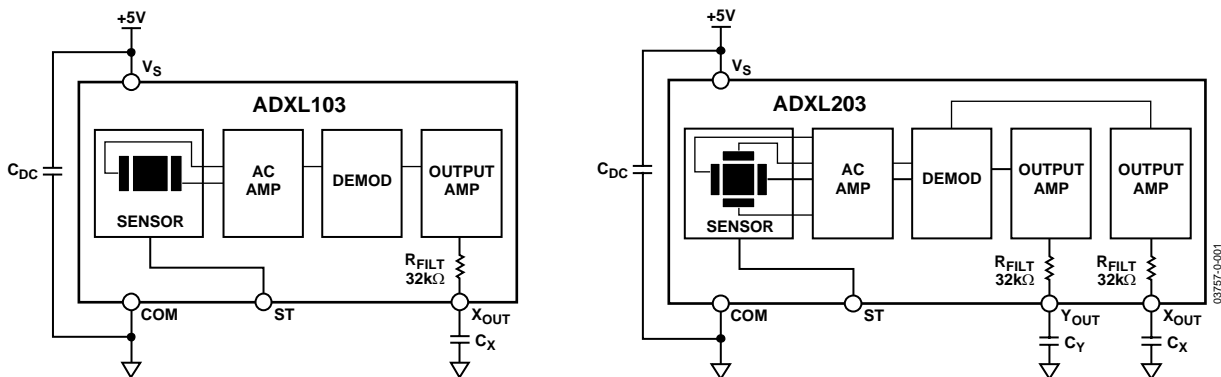

Figure 1. ADXL103/ADXL203 Functional Block Diagram

Rev. 0

Information furnished by Analog Devices is believed to be accurate and reliable. However, no responsibility is assumed by Analog Devices for its use, nor for any infringements of patents or other rights of third parties that may result from its use. Specifications subject to change without notice. No license is granted by implication or otherwise under any patent or patent rights of Analog Devices. Trademarks and registered trademarks are the property of their respective owners.

TABLE OF CONTENTS

Specifications.....	3	Self Test	9
Absolute Maximum Ratings.....	4	Design Trade-Offs for Selecting Filter Characteristics: The Noise/BW Trade-Off.....	9
Typical Performance Characteristics	5	Using the ADXL103/ADXL203 with Operating Voltages Other than 5 V.....	10
Theory of Operation	8	Using the ADXL203 as a Dual-Axis Tilt Sensor	10
Performance	8	Pin Configurations and Functional Descriptions.....	11
Applications.....	9	Outline Dimensions	12
Power Supply Decoupling	9	Ordering Guide	12
Setting the Bandwidth Using C_x and C_y	9		

REVISION HISTORY

Revision 0: Initial Version

SPECIFICATIONS

Table 1. $T_A = -40^\circ\text{C}$ to $+125^\circ\text{C}$, $V_S = 5\text{ V}$, $C_X = C_Y = 0.1\ \mu\text{F}$, Acceleration = 0 g , unless otherwise noted.

Parameter	Conditions	Min	Typ	Max	Unit
SENSOR INPUT	Each Axis				
Measurement Range ¹		± 1.7			<i>g</i>
Nonlinearity	% of Full Scale		± 0.5	± 2.5	%
Package Alignment Error			± 1		Degrees
Alignment Error (ADXL203)	X Sensor to Y Sensor		± 0.1		Degrees
Cross Axis Sensitivity			± 2	± 5	%
SENSITIVITY (Ratiometric) ²	Each Axis				
Sensitivity at X_{OUT} , Y_{OUT}	$V_S = 5\text{ V}$	940	1000	1060	mV/g
Sensitivity Change due to Temperature ³	$V_S = 5\text{ V}$		± 0.3		%
ZERO <i>g</i> BIAS LEVEL (Ratiometric)	Each Axis				
0 <i>g</i> Voltage at X_{OUT} , Y_{OUT}	$V_S = 5\text{ V}$	2.4	2.5	2.6	V
Initial 0 <i>g</i> Output Deviation from Ideal	$V_S = 5\text{ V}$, 25°C		± 25		mg
0 <i>g</i> Offset vs. Temperature			± 0.1		mg/ $^\circ\text{C}$
NOISE PERFORMANCE					
Output Noise	< 4 kHz, $V_S = 5\text{ V}$, 25°C		1	6	mV rms
Noise Density	@ 25°C		110		$\mu\text{g}/\sqrt{\text{Hz}}$ rms
FREQUENCY RESPONSE ⁴					
C_X , C_Y Range ⁵		0.002		10	μF
R_{FILT} Tolerance		24	32	40	k Ω
Sensor Resonant Frequency			5.5		kHz
SELF TEST ⁶					
Logic Input Low				1	V
Logic Input High		4			V
ST Input Resistance to Ground		30	50		k Ω
Output Change at X_{OUT} , Y_{OUT}	Self Test 0 to 1	400	750	1100	mV
OUTPUT AMPLIFIER					
Output Swing Low	No Load		0.3		V
Output Swing High	No Load		4.5		V
POWER SUPPLY					
Operating Voltage Range		3		6	V
Quiescent Supply Current			0.7	1.1	mA
Turn-On Time ⁷			20		ms

¹ Guaranteed by measurement of initial offset and sensitivity.

² Sensitivity is essentially ratiometric to V_S . For $V_S = 4.75\text{ V}$ to 5.25 V , sensitivity is 186 mV/V/g to 215 mV/V/g.

³ Defined as the output change from ambient-to-maximum temperature or ambient-to-minimum temperature.

⁴ Actual frequency response controlled by user-supplied external capacitor (C_X , C_Y).

⁵ Bandwidth = $1/(2 \times \pi \times 32\text{ k}\Omega \times C)$. For C_X , $C_Y = 0.002\ \mu\text{F}$, Bandwidth = 2500 Hz. For C_X , $C_Y = 10\ \mu\text{F}$, Bandwidth = 0.5 Hz. Minimum/maximum values are not tested.

⁶ Self-test response changes cubically with V_S .

⁷ Larger values of C_X , C_Y will increase turn-on time. Turn-on time is approximately $160 \times C_X$ or $C_Y + 4\text{ ms}$, where C_X , C_Y are in μF .

All minimum and maximum specifications are guaranteed. Typical specifications are not guaranteed.

ABSOLUTE MAXIMUM RATINGS

Table 2. ADXL103/ADXL203 Stress Ratings

Parameter	Rating
Acceleration (Any Axis, Unpowered)	3,500 g
Acceleration (Any Axis, Powered)	3,500 g
Drop Test (Concrete Surface)	1.2 m
V _s	-0.3 V to +7.0 V
All Other Pins	(COM - 0.3 V) to (V _s + 0.3 V)
Output Short-Circuit Duration (Any Pin to Common)	Indefinite
Operating Temperature Range	-55°C to +125°C
Storage Temperature	-65°C to +150°C

Table 3. Package Characteristics

Package Type	θ _{JA}	θ _{JC}	Device Weight
8-Lead CLCC	120°C/W	20°C/W	<1.0 gram

Stresses above those listed under Absolute Maximum Ratings may cause permanent damage to the device. This is a stress rating only; functional operation of the device at these or any other conditions above those indicated in the operational section of this specification is not implied. Exposure to absolute maximum rating conditions for extended periods may affect device reliability.

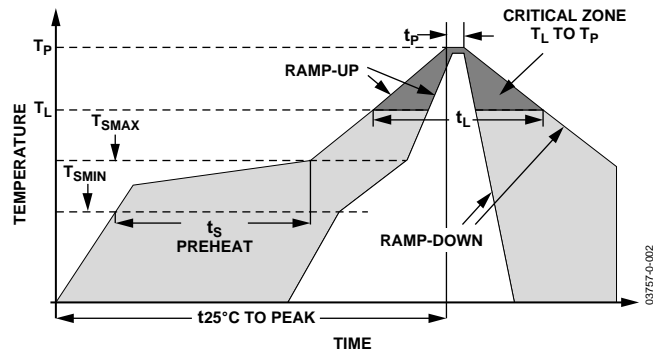

Profile Feature	Condition	
	Sn63/Pb37	Pb Free
Average Ramp Rate (T _L to T _P)	3°C/second Max	
Preheat		
• Minimum Temperature (T _{SMIN})	100°C	150°C
• Minimum Temperature (T _{SMAX})	150°C	200°C
• Time (T _{SMIN} to T _{SMAX}) (t _s)	60-120 seconds	60-150 seconds
T _{SMAX} to T _L		
• Ramp-Up Rate	3°C/second	
Time Maintained above Liquidous (T _L)		
• Liquidous Temperature (T _L)	183°C	217°C
• Time (t _L)	60-150 seconds	60-150 seconds
Peak Temperature (T _P)	240°C +0°C/-5°C	260°C +0°C/-5°C
Time within 5°C of Actual Peak Temperature (t _p)	10-30 seconds	20-40 seconds
Ramp-Down Rate	6°C/second Max	
Time 25°C to Peak Temperature	6 minutes Max	8 minutes Max

Figure 2. Recommended Soldering Profile

TYPICAL PERFORMANCE CHARACTERISTICS

($V_s = 5\text{ V}$ for all graphs, unless otherwise noted.)

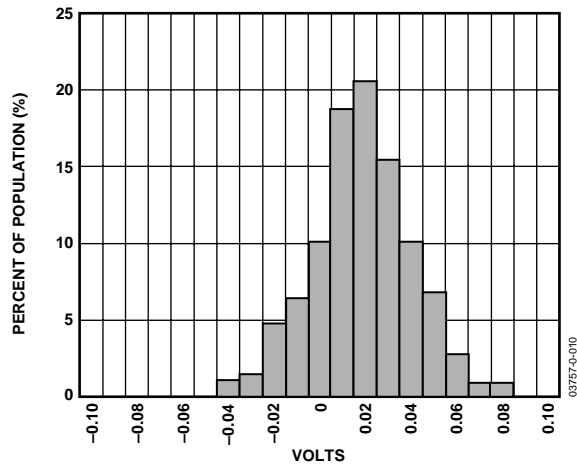

Figure 3. X Axis Zero g Bias Deviation from Ideal at 25°C

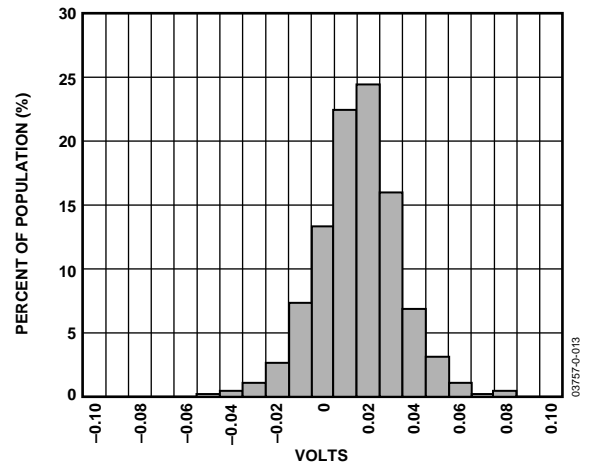

Figure 6. Y Axis Zero g Bias Deviation from Ideal at 25°C

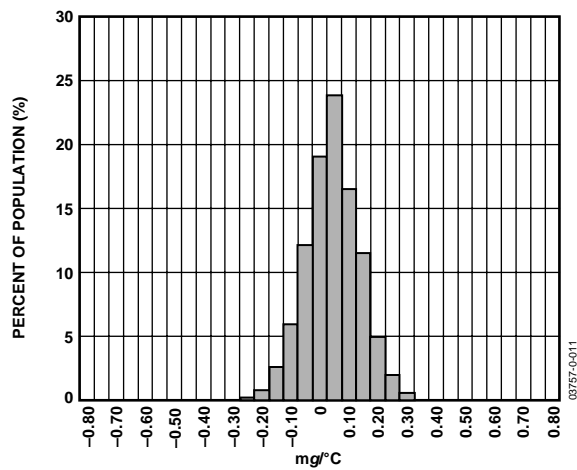

Figure 4. X Axis Zero g Bias Tempco

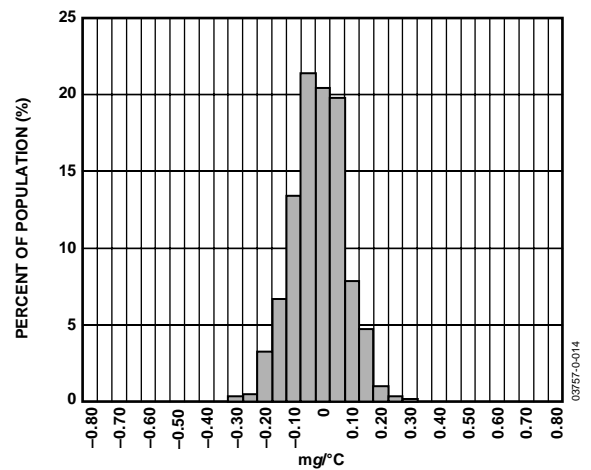

Figure 7. Y Axis Zero g Bias Tempco

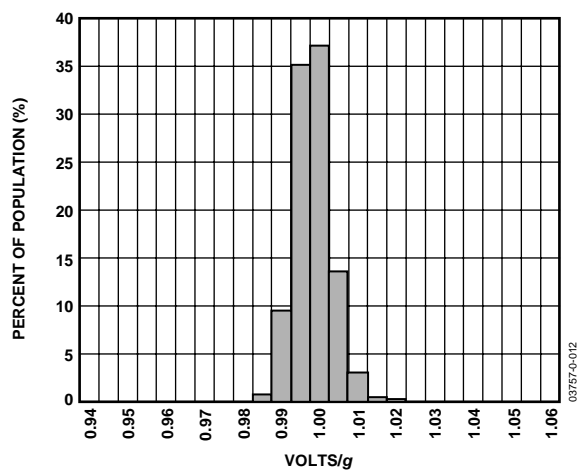

Figure 5. X Axis Sensitivity at 25°C

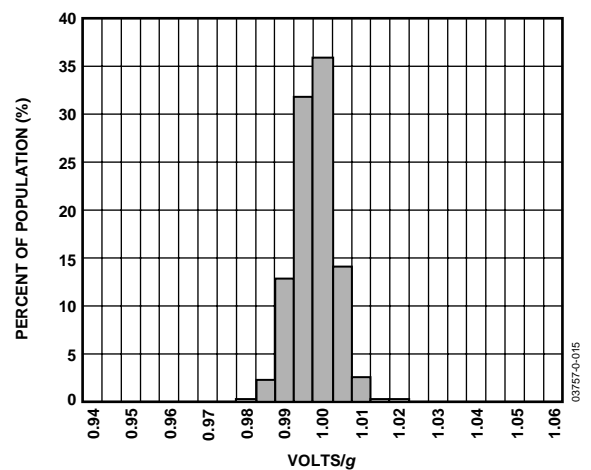

Figure 8. Y Axis Sensitivity at 25°C

ADXL103/ADXL203

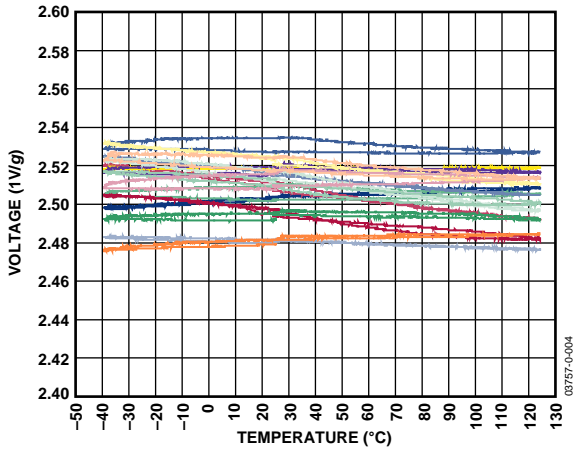

Figure 9. Zero g Bias vs. Temperature – Parts Soldered to PCB

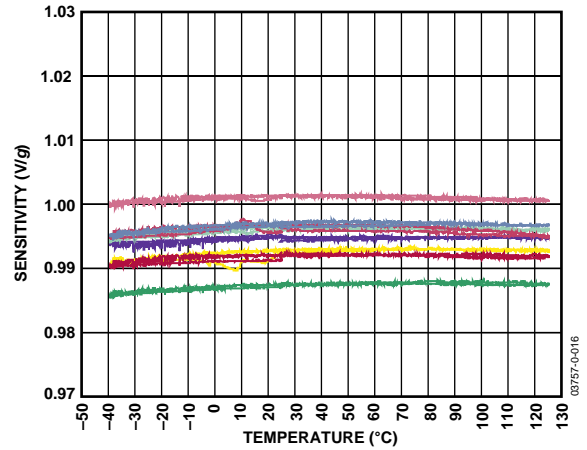

Figure 12. Sensitivity vs. Temperature – Parts Soldered to PCB

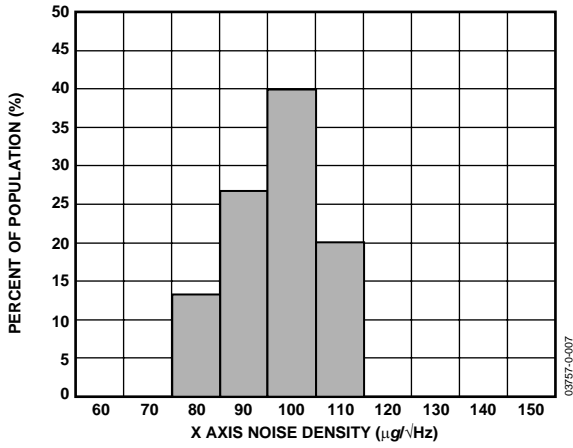

Figure 10. X Axis Noise Density at 25°C

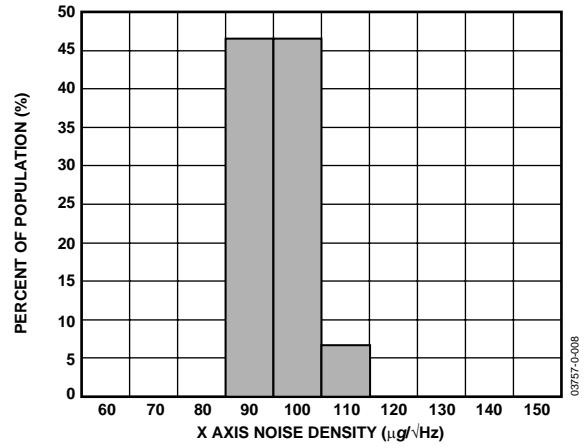

Figure 13. Y Axis Noise Density at 25°C

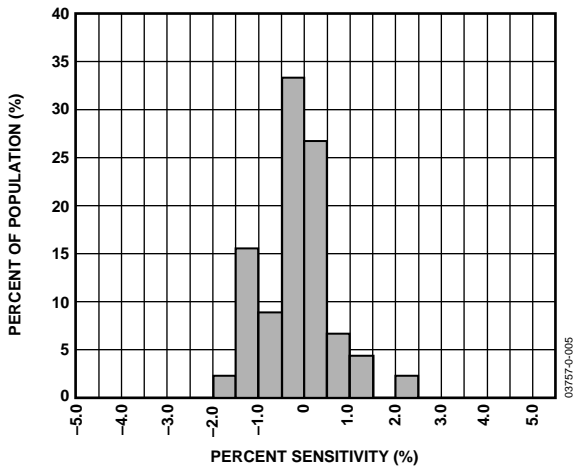

Figure 11. Z vs. X Cross-Axis Sensitivity

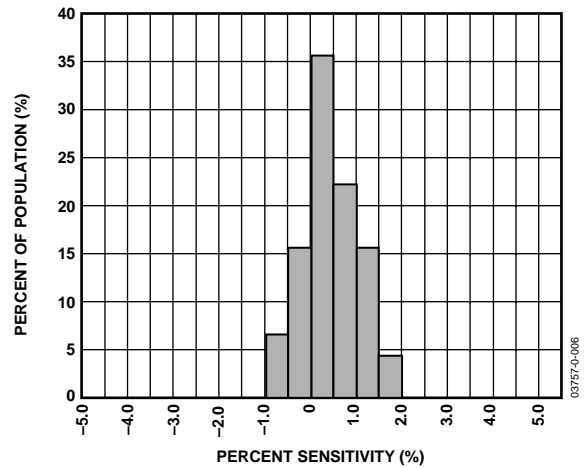

Figure 14. Z vs. Y Cross-Axis Sensitivity

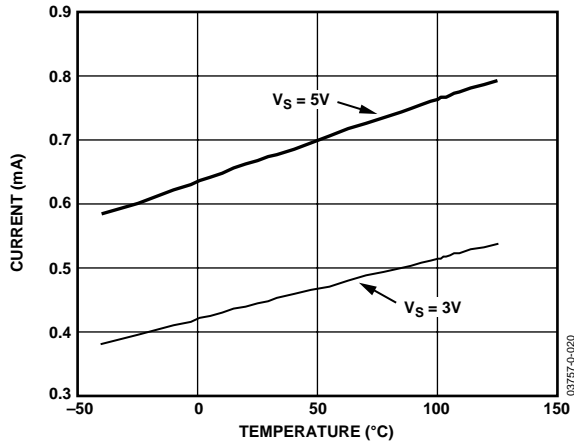

Figure 15. Supply Current vs. Temperature

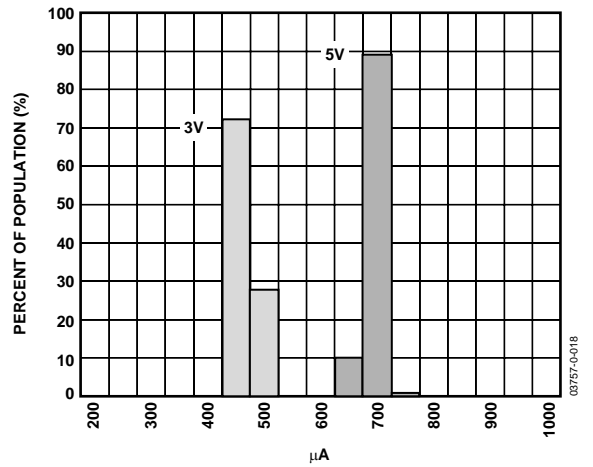

Figure 18. Supply Current at 25°C

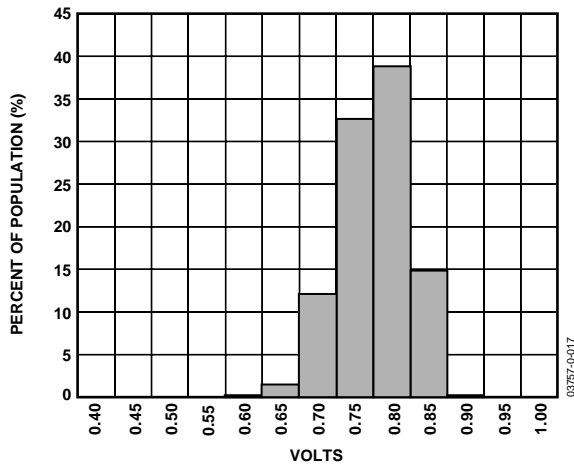

Figure 16. X Axis Self Test Response at 25°C

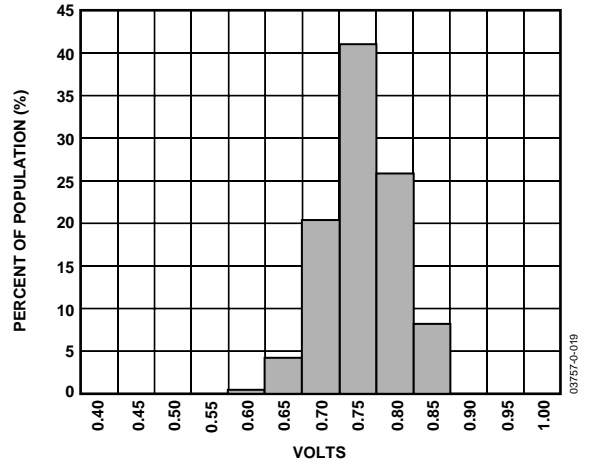

Figure 19. Y Axis Self Test Response at 25°C

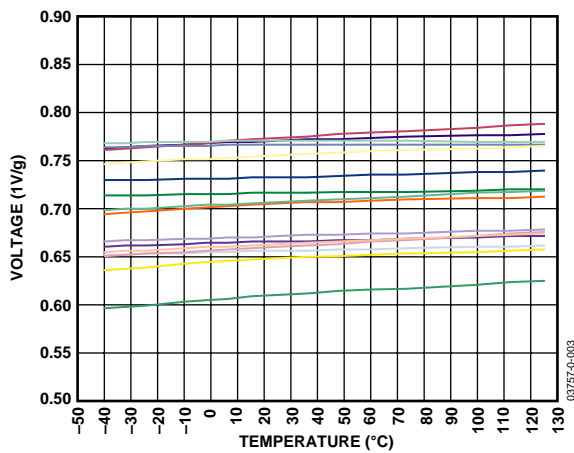

Figure 17. Self Test Response vs. Temperature

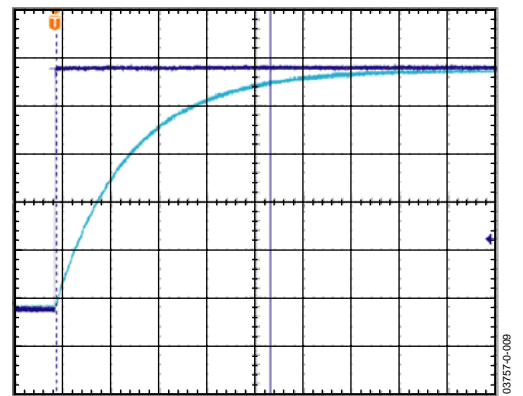

Figure 20. Turn-On Time - $C_x, C_y = 0.1 \mu F$, Time Scale = 2 ms/div

THEORY OF OPERATION

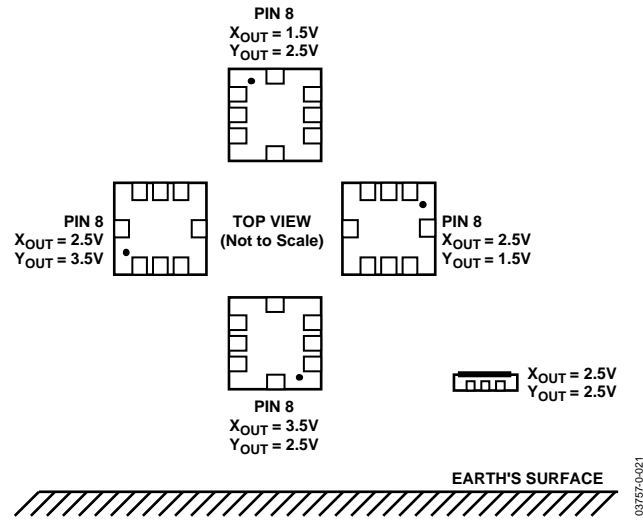

Figure 21. Output Response vs. Orientation

The ADXL103/ADXL203 are complete acceleration measurement systems on a single monolithic IC. The ADXL103 is a single axis accelerometer, while the ADXL203 is a dual axis accelerometer. Both parts contain a polysilicon surface-micromachined sensor and signal conditioning circuitry to implement an open-loop acceleration measurement architecture. The output signals are analog voltages proportional to acceleration. The ADXL103/ADXL203 are capable of measuring both positive and negative accelerations to at least $\pm 1.7 g$. The accelerometer can measure static acceleration forces such as gravity, allowing it to be used as a tilt sensor.

The sensor is a surface-micromachined polysilicon structure built on top of the silicon wafer. Polysilicon springs suspend the structure over the surface of the wafer and provide a resistance against acceleration forces. Deflection of the structure is measured using a differential capacitor that consists of independent fixed plates and plates attached to the moving mass. The fixed plates are driven by 180° out-of-phase square waves. Acceleration will deflect the beam and unbalance the differential capacitor, resulting in an output square wave whose amplitude is proportional to acceleration. Phase sensitive demodulation techniques are then used to rectify the signal and determine the direction of the acceleration.

The output of the demodulator is amplified and brought off-chip through a $32 k\Omega$ resistor. At this point, the user can set the signal bandwidth of the device by adding a capacitor. This filtering improves measurement resolution and helps prevent aliasing.

PERFORMANCE

Rather than using additional temperature compensation circuitry, innovative design techniques have been used to ensure high performance is built in. As a result, there is essentially no quantization error or non-monotonic behavior, and temperature hysteresis is very low (typically less than $10 mg$ over the $-40^\circ C$ to $+125^\circ C$ temperature range).

Figure 9 shows the zero g output performance of eight parts (X and Y axis) over a $-40^\circ C$ to $+125^\circ C$ temperature range.

Figure 12 demonstrates the typical sensitivity shift over temperature for $V_s = 5 V$. Sensitivity stability is optimized for $V_s = 5 V$, but is still very good over the specified range; it is typically better than $\pm 1\%$ over temperature at $V_s = 3 V$.

APPLICATIONS

POWER SUPPLY DECOUPLING

For most applications, a single 0.1 μF capacitor, C_{DC}, will adequately decouple the accelerometer from noise on the power supply. However in some cases, particularly where noise is present at the 140 kHz internal clock frequency (or any harmonic thereof), noise on the supply may cause interference on the ADXL103/ADXL203 output. If additional decoupling is needed, a 100 Ω (or smaller) resistor or ferrite beads may be inserted in the supply line of the ADXL103/ADXL203. Additionally, a larger bulk bypass capacitor (in the 1 μF to 22 μF range) may be added in parallel to C_{DC}.

SETTING THE BANDWIDTH USING C_X AND C_Y

The ADXL103/ADXL203 has provisions for bandlimiting the X_{OUT} and Y_{OUT} pins. Capacitors must be added at these pins to implement low-pass filtering for antialiasing and noise reduction. The equation for the 3 dB bandwidth is

$$F_{-3\text{ dB}} = 1/(2\pi(32\text{ k}\Omega) \times C_{(x,y)})$$

or more simply,

$$F_{-3\text{ dB}} = 5\ \mu\text{F}/C_{(x,y)}$$

The tolerance of the internal resistor (R_{FILT}) can vary typically as much as ±25% of its nominal value (32 kΩ); thus, the bandwidth will vary accordingly. A minimum capacitance of 2000 pF for C_X and C_Y is required in all cases.

Table 4. Filter Capacitor Selection, C_X and C_Y

Bandwidth (Hz)	Capacitor (μF)
1	4.7
10	0.47
50	0.10
100	0.05
200	0.027
500	0.01

SELF TEST

The ST pin controls the self-test feature. When this pin is set to V_S, an electrostatic force is exerted on the beam of the accelerometer. The resulting movement of the beam allows the user to test if the accelerometer is functional. The typical change in output will be 750 mg (corresponding to 750 mV). This pin may be left open-circuit or connected to common in normal use.

The ST pin should never be exposed to voltage greater than V_S + 0.3 V. If the system design is such that this condition cannot be guaranteed (i.e., multiple supply voltages present), a low V_F clamping diode between ST and V_S is recommended.

DESIGN TRADE-OFFS FOR SELECTING FILTER CHARACTERISTICS: THE NOISE/BW TRADE-OFF

The accelerometer bandwidth selected will ultimately determine the measurement resolution (smallest detectable acceleration). Filtering can be used to lower the noise floor, which improves the resolution of the accelerometer. Resolution is dependent on the analog filter bandwidth at X_{OUT} and Y_{OUT}.

The output of the ADXL103/ADXL203 has a typical bandwidth of 2.5 kHz. The user must filter the signal at this point to limit aliasing errors. The analog bandwidth must be no more than half the A/D sampling frequency to minimize aliasing. The analog bandwidth may be further decreased to reduce noise and improve resolution.

The ADXL103/ADXL203 noise has the characteristics of white Gaussian noise, which contributes equally at all frequencies and is described in terms of μg/√Hz (i.e., the noise is proportional to the square root of the accelerometer's bandwidth). The user should limit bandwidth to the lowest frequency needed by the application in order to maximize the resolution and dynamic range of the accelerometer.

With the single pole roll-off characteristic, the typical noise of the ADXL103/ADXL203 is determined by

$$rmsNoise = (110\mu\text{g}/\sqrt{\text{Hz}}) \times (\sqrt{BW \times 1.6})$$

At 100 Hz, the noise is

$$rmsNoise = (110\mu\text{g}/\sqrt{\text{Hz}}) \times (\sqrt{100 \times 1.6}) = 1.4\text{mg}$$

Often, the peak value of the noise is desired. Peak-to-peak noise can only be estimated by statistical methods. Table 5 is useful for estimating the probabilities of exceeding various peak values, given the rms value.

Table 5. Estimation of Peak-to-Peak Noise

Peak-to-Peak Value	% of Time That Noise Will Exceed Nominal Peak-to-Peak Value
2 × RMS	32
4 × RMS	4.6
6 × RMS	0.27
8 × RMS	0.006

ADXL103/ADXL203

Peak-to-peak noise values give the best estimate of the uncertainty in a single measurement. Table 6 gives the typical noise output of the ADXL103/ADXL203 for various C_x and C_y values.

Table 6. Filter Capacitor Selection (C_x , C_y)

Bandwidth(Hz)	C_x , C_y (μ F)	RMS Noise (mg)	Peak-to-Peak Noise Estimate (mg)
10	0.47	0.4	2.6
50	0.1	1.0	6
100	0.047	1.4	8.4
500	0.01	3.1	18.7

USING THE ADXL103/ADXL203 WITH OPERATING VOLTAGES OTHER THAN 5 V

The ADXL103/ADXL203 is tested and specified at $V_s = 5$ V; however, it can be powered with V_s as low as 3 V or as high as 6 V. Some performance parameters will change as the supply voltage is varied.

The ADXL103/ADXL203 output is ratiometric, so the output sensitivity (or scale factor) will vary proportionally to supply voltage. At $V_s = 3$ V the output sensitivity is typically 560 mV/g.

The zero g bias output is also ratiometric, so the zero g output is nominally equal to $V_s/2$ at all supply voltages.

The output noise is not ratiometric but is absolute in volts; therefore, the noise density decreases as the supply voltage increases. This is because the scale factor (mV/g) increases while the noise voltage remains constant. At $V_s = 3$ V, the noise density is typically 190 μ g/ $\sqrt{\text{Hz}}$.

Self-test response in g is roughly proportional to the square of the supply voltage. However, when ratiometricity of sensitivity is factored in with supply voltage, self-test response in volts is roughly proportional to the cube of the supply voltage. So at $V_s = 3$ V, the self-test response will be approximately equivalent to 150 mV, or equivalent to 270 mg (typical).

The supply current decreases as the supply voltage decreases. Typical current consumption at $V_{DD} = 3$ V is 450 μ A.

USING THE ADXL203 AS A DUAL-AXIS TILT SENSOR

One of the most popular applications of the ADXL203 is tilt measurement. An accelerometer uses the force of gravity as an input vector to determine the orientation of an object in space.

An accelerometer is most sensitive to tilt when its sensitive axis is perpendicular to the force of gravity, i.e., parallel to the earth's surface. At this orientation, its sensitivity to changes in tilt is highest. When the accelerometer is oriented on axis to gravity, i.e., near its +1 g or -1 g reading, the change in output acceleration per degree of tilt is negligible. When the accelerometer is perpendicular to gravity, its output will change nearly 17.5 mg per degree of tilt. At 45°, its output changes at only 12.2 mg per degree and resolution declines.

Dual-Axis Tilt Sensor: Converting Acceleration to Tilt

When the accelerometer is oriented so both its X axis and Y axis are parallel to the earth's surface, it can be used as a 2-axis tilt sensor with a roll axis and a pitch axis. Once the output signal from the accelerometer has been converted to an acceleration that varies between -1 g and +1 g, the output tilt in degrees is calculated as follows:

$$PITCH = ASIN(A_x/1 g)$$

$$ROLL = ASIN(A_y/1 g)$$

Be sure to account for overranges. It is possible for the accelerometers to output a signal greater than ± 1 g due to vibration, shock, or other accelerations.

PIN CONFIGURATIONS AND FUNCTIONAL DESCRIPTIONS

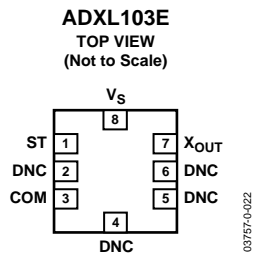

Figure 22. ADXL103 8-Lead CLCC

Table 7. ADXL103 8-Lead CLCC Pin Function Descriptions

Pin No.	Mnemonic	Description
1	ST	Self Test
2	DNC	Do Not Connect
3	COM	Common
4	DNC	Do Not Connect
5	DNC	Do Not Connect
6	DNC	Do Not Connect
7	X _{OUT}	X Channel Output
8	V _S	3 V to 6 V

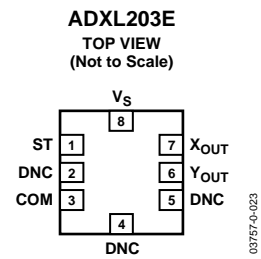

Figure 23. ADXL203 8-Lead CLCC

Table 8. ADXL203 8-Lead CLCC Pin Function Descriptions

Pin No.	Mnemonic	Description
1	ST	Self Test
2	DNC	Do Not Connect
3	COM	Common
4	DNC	Do Not Connect
5	DNC	Do Not Connect
6	Y _{OUT}	Y Channel Output
7	X _{OUT}	X Channel Output
8	V _S	3 V to 6 V

ADXL103/ADXL203

OUTLINE DIMENSIONS

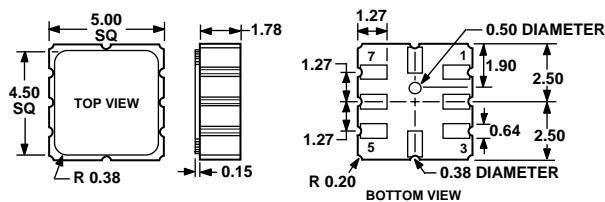

Figure 24. 8-Terminal Ceramic Leadless Chip Carrier [LCC]
(E-8)

Dimensions shown in millimeters

ESD CAUTION

ESD (electrostatic discharge) sensitive device. Electrostatic charges as high as 4000 V readily accumulate on the human body and test equipment and can discharge without detection. Although this product features proprietary ESD protection circuitry, permanent damage may occur on devices subjected to high energy electrostatic discharges. Therefore, proper ESD precautions are recommended to avoid performance degradation or loss of functionality.



ORDERING GUIDE

ADXL103/ADXL203 Products	Number of Axes	Specified Voltage (V)	Temperature Range	Package Description	Package Option
ADXL103CE ¹	1	5	-40°C to +125°C	8-Lead Ceramic Leadless Chip Carrier	E-8
ADXL103CE-REEL ¹	1	5	-40°C to +125°C	8-Lead Ceramic Leadless Chip Carrier	E-8
ADXL203CE ¹	2	5	-40°C to +125°C	8-Lead Ceramic Leadless Chip Carrier	E-8
ADXL203CE-REEL ¹	2	5	-40°C to +125°C	8-Lead Ceramic Leadless Chip Carrier	E-8
ADXL203EB Evaluation Board				Evaluation Board	

¹ Lead finish—Gold over Nickel over Tungsten.